

UE-48LI2500I ESS Unit User Manual

Upower
ecoline



Content

SAFETY PRECAUTIONS.....	1
PREFACE.....	2
1 INTRODUCTION.....	3
1.1 BRIEF INTRODUCTION.....	3
1.2 PRODUCT PROPERTIES.....	3
1.3 PRODUCT IDENTITY DEFINITION.....	3
2 PRODUCT SPECIFICATION.....	5
2.1 SIZE AND WEIGHT.....	5
2.2 PERFORMANCE PARAMETER.....	5
2.3 INTERFACE DEFINITION.....	5
2.3.1 DIP switch definition and description.....	6
2.4 BATTERY MANAGEMENT SYSTEM(BMS).....	9
2.4.1 Voltage Protection.....	9
2.4.2 Current Protection.....	9
2.4.3 Temperature Protection.....	10
2.4.4 Other Protection.....	10
3 INSTALLATION AND CONFIGURATION.....	11
3.1 READY FOR INSTALLATION.....	11
3.1.1 Environmental requirements.....	11
3.1.2 Tools and data.....	11
3.1.3 Technical preparation.....	12
3.1.4 Unpacking inspection.....	12
3.1.5 Engineering coordination.....	14
3.2 EQUIPMENT INSTALLATION.....	14
3.2.1 Installation preparation.....	14
3.2.2 Mechanical installation.....	15
3.2.3 Electrical installation.....	16
3.2.4 Battery parameter settings on the inverter.....	18
4 USE, MAINTENANCE AND TROUBLESHOOTING.....	19
4.1 BATTERY SYSTEM USAGE AND OPERATION INSTRUCTIONS.....	19
4.2 ALARM DESCRIPTION AND PROCESSING.....	20
4.3 ANALYSIS AND TREATMENT OF COMMON FAULTS.....	21

Safety Precautions



Warning

- Please do not put the battery into water or fire, in case of explosion or any other situation that might endanger your life.
- Please connect wires properly while installation, do not reverse connect.
- To avoid short circuit, please do not connect positive and negative poles with conductor on the same device.
- Please avoid any form of damage to battery, especially stab, hit, trample or strike.
- Please shut off the power completely when removing the device or reconnecting wires during the daily use or it could cause the danger of electric shock.
- Please use dry powder extinguisher to put out the flame when encountering a fire hazard, liquid extinguisher could result in the risk of explosion.
- For your safety, please do not arbitrarily dismantle any component in any circumstances. The maintenance must be implemented by authorized technical personnel or our company's technical support. Device breakdown due to unauthorized operation will not be covered under warranty.



Caution

- Our product have been strictly inspected before shipment. Please contact us if you find any abnormal phenomena such as device outer case bulging.
- The product shall be grounded properly before use In order to ensure your safety.
- To assure the proper use please make sure parameters among the relevant device are compatible and matched.
- Please do not mixed-use batteries from different manufacturers, different types and models, as well as old and new together.
- Ambient and storage method could impact the product life span, please comply with the operation environment instruction to ensure device works in proper condition.
- For long-term storage, the battery should be recharged once every 6 months, and the amount of electric charge shall exceed 80% of the rated capacity.
- Please charge the battery in 18 hours after it fully discharged or over-discharging protection mode is activated.
- Formula of theoretical standby time: $T=C/I$ (T is standby time, C is battery capacity, I is total current of all loads).

Preface

Manual declaration

UE-48LI2500I lithium iron phosphate battery energy storage system can provide energy storage for photovoltaic power generation users through parallel combination. Our product can store extra electricity into battery from photovoltaic power generation system in daytime and supply stable power to user's equipment as power backup at nighttime or any time when needed. It can improve the efficiency of photovoltaic power generation and increase the electric power efficiency by peak load shifting.

This user manual details the basic structure, parameters, basic procedures and methods of installation and operation and maintenance of the equipment.

1 Introduction

1.1 Brief Introduction

UE-48LI2500I lithium iron phosphate battery system is a standard battery system unit, customers can choose a certain number of UE-48LI2500I according to their needs, by connecting parallel to form a larger capacity battery pack, to meet the user's long-term power supply needs. The product is especially suitable for energy storage applications with high operating temperatures, limited installation space, long power backup time and long service life.

1.2 Product Properties

UE-48LI2500I energy storage product's anode materials are lithium iron phosphate, battery cells are managed effectively by BMS with better performance, the system's features as below:

- Comply with European ROHS, Certified SGS, employ non-toxic, non-pollution environment-friendly battery.
- Anode materials are lithium iron phosphate (LiFePO4), safer with longer life span.
- Carries battery management system with better performance, possesses protection function like over-discharge, over-charge, over-current, abnormal temperature.
- Self-management on charging and discharging, Single core balancing function.
- Intelligent design configures integrated inspection module.
- Flexible configurations allow parallel of multi-battery for longer standby time.
- Self-ventilation with lower system noise.
- Less battery self-discharge, then recharging period can be up to 10 months during the storage.
- No memory effect so that battery can be charged and discharged shallowly.
- With wide range of temperature for working environment, -20°C ~ +55 °C, circulation span and discharging performance are well under high temperature.
- Less volume, lighter weight.

1.3 Product identity definition

Figure 1-1 Battery Energy Storage System nameplate

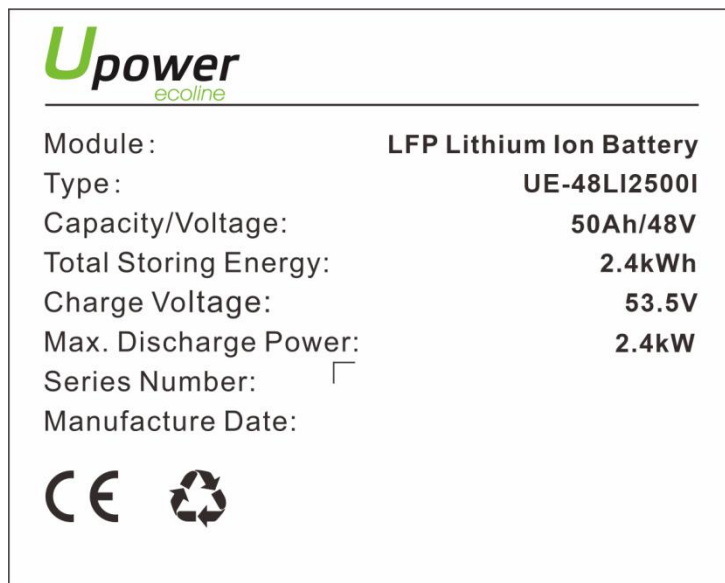

	<p>Battery voltage is higher than safe voltage, direct contact with electric shock hazard.</p>
	<p>Be careful with your actions and be aware of the dangers.</p>
	<p>Read the user manual before using.</p>
	<p>The scrapped battery cannot be put into the garbage can and must be professionally recycled.</p>
	<p>After the battery life is terminated, the battery can continue to be used after it recycled by the professional recycling organization and do not discard it at will.</p>
	<p>This battery product meets European directive requirements.</p>
<div style="border: 1px solid black; padding: 5px;"> <div style="background-color: red; color: white; text-align: center; padding: 2px;">DANGER</div> <div style="text-align: center; font-size: 8px; color: red;">HIGH VOLTAGE INSIDE</div> <div style="display: flex; justify-content: space-between; align-items: flex-start; padding: 5px;"> <div style="width: 30%;"> </div> <div style="width: 65%;"> <ul style="list-style-type: none"> * Do not disconnect, disassemble or repair by yourself. * Do not drop, deform, impact, cut or separate with a sharp object. * Do not place near open flame or incinerate. * Do not sit or put heavy things on battery. * Keep away from moisture or liquid. * Keep out of reach of children, animals or insects. * Contact the supplier within 24 hours if anything wrong. <p>Emergency Situations</p> <ul style="list-style-type: none"> * If leaking, fire, wet or damaged, switch off the breaker and go away from the battery. * Do not touch the leaking liquid. Do not use water, sand or dry powder extinguisher is usable. </div> </div> </div> <p style="margin-top: 10px;">Dangerous goods warning label on the top of the battery module</p>	

2 Product Specification

2.1 Size and Weight

Table 2-1 UE-48LI2500I Device size

Product	Nominal Voltage	Nominal Capacity	Dimension	Weight
UE-48LI2500I	DC48V	50Ah	480×360×90mm	≈22kg

2.2 Performance Parameter

Table 2-2 UE-48LI2500I performance parameter

Item	UE-48LI2500I Parameter value
Nominal Voltage(V)	48
Work Voltage Range(V)	42~54
Nominal Capacity(Ah)	50
Nominal Energy(kWh)	2.4
Nominal Power(kW)	0.7
Max Power(kW)	2.4
1S Peak Power(kW)	2.64
1S Peak Current(A)	55
Charging Current(A)	25
Discharge Current(A)	25

2.3 Interface Definition

This section elaborates the interface functions of the front interface of the device.

Figure2-1 The sketch of interface.

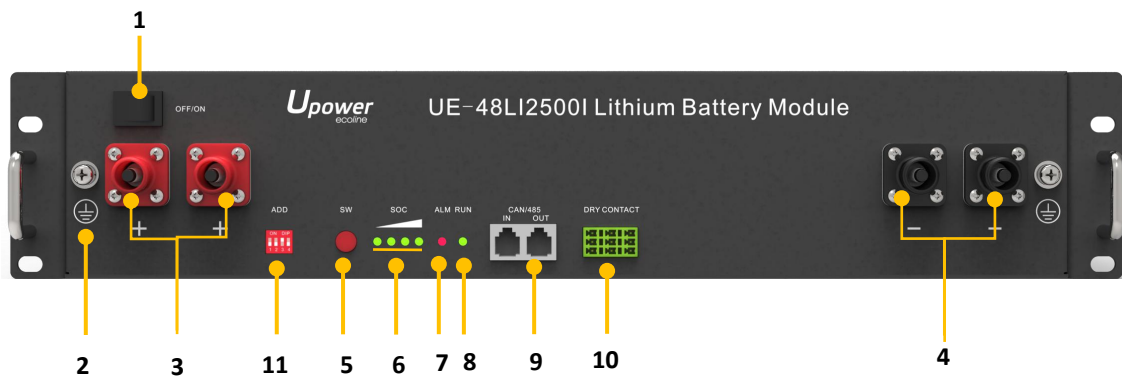

Table 2-3 Interface Definition

Item	Name	Definition
1	Power switch	OFF/ON, must be in the "ON" state when in use
2	Ground connection point	Shell ground connection
3	Positive socket	Battery output positive or parallel positive line
4	Negative socket	Battery output negative or parallel negative line
5	SW (battery wake/sleep switch)	When the "OFF/ON" switch button is in the ON state, press and hold this button for 3 seconds to put the battery into the power-on or sleep state.
6	SOC	The number of green lights on shows the remaining battery power. See Table 2-3 for details.
7	ALM	Red light flashing when an alarm occurs, red light always on during protection status. After the condition of trigger protection is released, it can be automatically closed.
8	RUN	Green light flashing during standby and charging mode. Green light always on when discharging.
9	CAN/485	Communication port, support CAN/ RS485 communication (factory default CAN communication)
10	DRY CONTACT	/
11	ADD	DIP switch

2.3.1 DIP switch definition and description

Table 2-4 Interface Definition

DIP switch position (master communication protocol and baud rate selection)			
#1	#2	#3	#4
Define different protocols; Distinguish between master and slave			Baud rate selection
			OFF: CAN: 500K,485: 9600
			ON: CAN: 250K,485: 115200

DIP switch description:

When the batteries are connected in parallel, the master communicates with the slaves through the CAN interface. The master summarizes the information of the entire battery system and communicates with the inverter through CAN or 485.

1. If the master is the latest UE-48LI2500I battery with DIP switch:

(1) The communication cable from the master CAN IN to the inverter comm port should be the correct one.

(2) When the battery works with Beta, GOODWE, Solis, LUX, Sofar, DEYE, VICTRON, IMEON, Sungrow, SMA, RENAC, DELIOS, SAJ (CAN Comm), before starting the battery, you need put the master DIP switch "# 3" to the "ON" position (to the top), then turn on the batteries.



(3) If the battery communicates with the Omega, Axpert-king/VMIII/MAX, Infinisolar, Growatt SPH/SPA (CAN comm), GMDE, turn the master DIP switch "#2" to "ON" position.



(4) If the battery communicates with the Growatt SPF HVM-P/ES/WPV by RS485 communication, turn the master DIP switch "#2" and "#3" to "ON".



(5) If the battery communicates with the Schneider Conext Series, turn the master DIP switch "#1" and "#3" to "ON".



(6) When you setup the master DIP as setting 1~4, all the slaves keep the DIP 0000, no need change.

(7) If the battery module is in communication with the ICC by 485 communication, turn the master DIP switch "#1" and "#4" to "ON".



the DIP switch of slaves need to turn the "#4" to "ON" at the same time while the master is setting 5.



(8) If the energy storage system has only one UE-48LI2500I, it is the master itself, and still follow the above steps.

Note: For more information of matching inverter brands, please subject to the latest document <The list of compatibility between ESS and Inverters >.

Caution: The DIP switch mode in case (7), 1001 is only for ICC (a special communication device of some no-communication inverter), it's a special firmware in BMS, different from general firmware, so if customers want to use that, please contact us to confirm.

Figure 2-2 CAN/485 interface definition

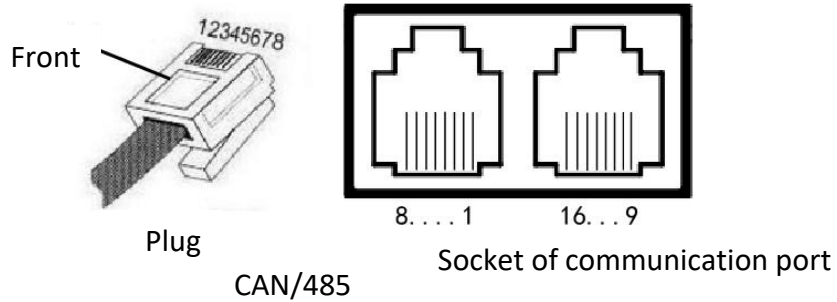

Table 2-4 Pin Definition

Foot position	Color	Definition
PIN1	Orange/white	485A
PIN2	Orange	XGND
PIN3	Green/white	485B
PIN4	Blue	CANH
PIN5	Blue/white	CANL
PIN6	Green	Reserve
PIN7	Brown/white	XIN
PIN8	Brown	Reserve
PIN9	Orange/white	Reserve
PIN10	Orange	XGND
PIN11	Green/white	Reserve
PIN12	Blue	CANH
PIN13	Blue/white	CANL
PIN14	Green	Reserve
PIN15	Brown/white	XOUT
PIN16	Brown	Reserve

Table 2-5 LED status indicators

Battery Status	SOC	LED1	LED2	LED3	LED4	ALM	RUN
Shutdown	/	off	off	off	off	off	off
Standby	$75\% \leq \text{SOC} \leq 100\%$	●	●	●	●	off	Flashing
	$50\% \leq \text{SOC} < 75\%$	●	●	●	off	off	Flashing
	$25\% \leq \text{SOC} < 50\%$	●	●	off	off	off	Flashing
	$5\% < \text{SOC} < 25\%$	●	off	off	off	off	Flashing
	$0\% < \text{SOC} \leq 5\%$	●	off	off	off	Flashing	Flashing
	SOC=0	off	off	off	off	Flashing/ ●	Flashing
Charging	SOC=100%	●	●	●	●	off	Flashing
	$75\% \leq \text{SOC} < 100\%$	●	●	●	Flashing	off	Flashing
	$50\% \leq \text{SOC} < 75\%$	●	●	Flashing	off	off	Flashing
	$25\% \leq \text{SOC} < 50\%$	●	Flashing	off	off	off	Flashing
	$0\% < \text{SOC} < 25\%$	Flashing	off	off	off	off	Flashing
Discharging	$75\% \leq \text{SOC} \leq 100\%$	●	●	●	●	off	●
	$50\% \leq \text{SOC} < 75\%$	●	●	●	off	off	●
	$25\% \leq \text{SOC} < 50\%$	●	●	off	off	off	●
	$5\% < \text{SOC} < 25\%$	●	off	off	off	off	●
	$0\% < \text{SOC} \leq 5\%$	●	off	off	off	Flashing	●
	SOC=0	off	off	off	off	Flashing/ ●	Flashing

A special ALM light flashing state: when the communication between batteries is lost or abnormal, all the lights from SOC to RUN of the master battery will flash together.

● means green light always on ● means red light always on

Flashing: means green light flashing or red light flashing

2.4 Battery Management System(BMS)

2.4.1 Voltage Protection

Low Voltage Protection in Discharging:

When any battery cell voltage or total voltage is lower than the protection value during discharging, the over-discharging mode is activated, and the battery buzzer makes an alarm sound. Then battery system stops supplying power to the outside. When the voltage of each cell back to rated return range, the protection is over.

Over Voltage Protection in Charging:

Battery will stop charging when total voltage or any battery cell voltage reaches the rated protection value during charging stage. When total voltage or all cell back to rated range, the protection is over.

2.4.2 Current Protection

Over Current Protection in Charging:

When the charge current > 45A, current limit protection mode is activated, current will be limited to 4A, protection is removed after rated time delaying 10S. Circulate like this until the current is lower than 45A.

Over Current Protection in Discharging:

When the discharging current is greater than the protection value 55A, the battery buzzer alarms and the system stops discharging. Protection is removed after rated time delaying 1min.

**Caution:**

The buzzer sound alarm setting can be manually turned off on the background software, and the factory default is on.

2.4.3 Temperature Protection

Low/Over temperature protection in charging:

When battery's temperature is beyond range of $-5^{\circ}\text{C} \sim +55^{\circ}\text{C}$ during charging, temperature protection is activated, device stops charging.

The protection is over when temperature back to rated working range.

Low/Over temperature protection in discharging:

When battery's temperature is beyond range of $-20^{\circ}\text{C} \sim +55^{\circ}\text{C}$ during discharging, temperature protection is activated, device stops supplying power to the outside.

The protection is over when temperature back to rated working range..

2.4.4 Other Protection

Short Circuit Protection:

When the battery is activated from the shutdown state, if a short circuit occurs, the system starts short-circuit protection for 60 seconds.

Self-Shutdown:

When device connects no external loads and power supply and no external communication for over 72 hours, device will dormant standby automatically.

**Caution**

Battery's maximum discharging current should be more than load's maximum working current.

3 Installation and Configuration

3.1 Ready for installation

Safety Requirement

This system can only be installed by personnel who have been trained in the power supply system and have sufficient knowledge of the power system.
 The safety regulations and local safety regulations listed below should always be followed during the installation.

- All circuits connected to this power system with an external voltage of less than 48V must meet the SELV requirements defined in the IEC60950 standard.
- If operating within the power system cabinet, make sure the power system is not charged. Battery devices should also be switched off.
- Distribution cable wiring should be reasonable and has the protective measures to avoid touching these cables while operating power equipment.
- when installing the battery system, must wear the protective items below:



The isolation gloves



Safety goggles



Safety shoes

Figure3-1

3.1.1 Environmental requirements

Working temperature: -20 °C ~ +55 °C

- Charging temperature range is 0 °C ~ +55 °C,
- Discharging temperature range is -20 °C ~ +55 °C

Storage temperature: -10 °C ~ +35 °C

Relative humidity: 5% ~ 85%RH

Elevation: no more than 4000m

Operating environment: Indoor installation, sites avoid the sun and no wind, no conductive dust and corrosive gas.

And the following conditions are met:

- Installation location should be away from the sea to avoid brine and high humidity environment.
- The ground for product arrangement shall be flat and level
- There is no flammable explosive materials near to the installation site.
- The optimal ambient temperature is 15 °C ~ 30 °C
- Keep away from dust and messy zones

3.1.2 Tools and data

Hardware tool

Tools and meters that may be used are shown in table 3-1.

Table 3-1 Tool instrument

Name	
Screwdriver (Slotted、Phillips)	Multimeter
Torque wrench	Clamp current meter
Diagonal pliers	Insulation tape
Pointed nose pliers	Temperature meter
Pliers to hold the wire	Anti-static bracelet
Stripping pliers	Cable tie
Electric drill	Tape measure

3.1.3 Technical preparation

Electrical interface check

Devices that can be connected directly to the battery can be user equipment, power supplies, or other power supplies.

- Confirm whether the user's PV power generation equipment, power supply or other power supply equipment has a DC output interface, and measure whether the DC power output voltage meets the voltage range requirements in Table 2-2.
- Confirm that the maximum discharge current capability of the DC power interface of the user's photovoltaic power generation equipment, power supply or other power supply equipment should be greater than the maximum charging current of the products used in Table 2-2.

If the maximum discharge capacity of the DC power interface of the user's photovoltaic power generation equipment is less than the maximum charging current of the products used in Table 2-2, the DC power interface of the user's photovoltaic power generation equipment shall have a current limiting function to ensure the normal operation of the user's equipment.

- Verify that the maximum operating current of the battery-powered user equipment (inverter DC input) should be less than the maximum discharge current of the products used in Table 2-2.









The security check

- Firefighting equipment should be provided near the product, such as portable dry powder fire extinguisher.
- Automatic fire fighting system shall be provided for the case where necessary.
- No flammable, explosive and other dangerous product are placed beside the battery.

3.1.4 Unpacking inspection

- When the equipment arrives at the installation site, loading and unloading should be carried out according to the rules and regulations, to prevent from being exposed to sun and rain.
- Before unpacking, the total number of packages shall be indicated according to the shipping list attached to each package, and the case shall be checked for good condition.
- In the process of unpacking, handle with care and protect the surface coating of the object.
- Open the package, the installation personnel should read the technical documents, verify the list, according to the configuration table and packing list, ensure objects are complete and intact, if the internal packing is damaged, should be examined and recorded in detail.

Packing list is as follows:

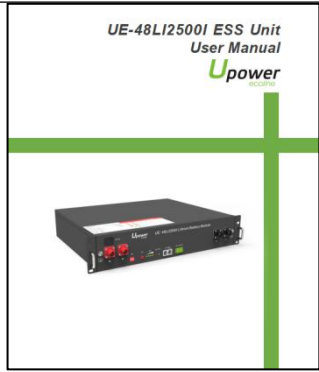
Item	Specification	Quantity	Figure
Battery-UE-48LI2500I	48V/50Ah 480×360×90mm	1	
Power cable-positive	Red /25mm ² /L2050mm	Optional: If you need, please contact the dealer to purchase	
Power cable-negative	Black /25mm ² /L2050mm	Optional: If you need, please contact the dealer to purchase	
Parallel cable-positive	Red /25mm ² /L215mm	1	
Parallel cable-negative	Black /25mm ² /L215mm	1	
Communication parallel cable	Black /L250mm/Double RJ45 plug	1	
Communication cable-to inverter	Black /L2000mm /Double RJ45 plug	1	
Ground wire	L500mm,4mm ²	1	
User Manual	UE-48LI2500I User manual	1	

Screw	Combination screws M6*14	4	
-------	-----------------------------	---	--

3.1.5 Engineering coordination

Attention should be paid to the following items before construction:

- Power line specification.
The power line specification shall meet the requirements of maximum discharge current for each product.
- Mounting space and bearing capacity.
Make sure that the battery has enough room to install, and that the battery rack and bracket have enough load capacity.
- Wiring.
Make sure the power line and ground wire are reasonable. Not easy to short-circuit, water and corrosion.

3.2 Equipment installation

Table 3-2 Installation steps

Step1	Installation preparation	Confirm that the ON/OFF switch on the front panel of UE-48LI2500I unit is in the "OFF" state to ensure no live operation.
Step 2	Mechanical installation	1. Battery placement position determination
		2. Battery module installation
Step3	Electrical installation	1. Ground cable installation
		2. Battery module parallel cable installation
		3. Parallel communication cable connection
Step4	Battery system self-test	1. Turn the ON/OFF switch to the "ON" state
		2. Press SW button 3S to wake up battery
		3. Check the system output voltage and led status
		4. Shut down the system
Step5	Connecting inverter	1. Connect total positive & total negative cable of the battery system to the inverter
		2. Battery module total positive cable installation
		3. Battery module total negative cable installation
		4. Connect the communication cable from the master CAN IN to the inverter
		5. Turn on the Power switch and wake up system by SW button
		6. Close the DC breaker between inverter and battery
		7. Turn on the inverter and check the communication between inverter and battery system

3.2.1 Installation preparation

1. Prepare equipment and tools for installation.
2. Check the UE-48LI2500I unit and confirm that the ON/OFF switch is in the "OFF" state to ensure the device is shut off.

3.2.2 Mechanical installation

Installation method 1: With Cabinet installation

1. Place the UE-48LI2500I unit on the cabinet bracket as shown in the figure and push the device into the cabin at the installation position. (The cabinet structure in the figure is for reference only)
2. Secure the UE-48LI2500I unit to the cabinet with a nut through the mounting holes top on the hanging ears of the UE-48LI2500I unit.

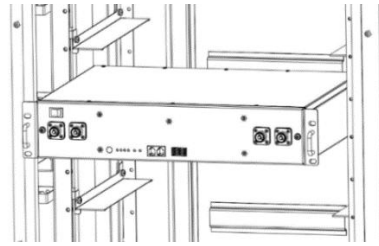

Figure3-2

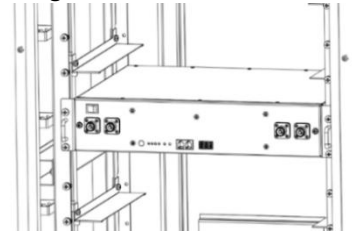

Figure3-3

Installation method 2: With Simple bracket installation

1. Place the UE-48LI2500I and brackets as shown in the figure3-4, and insert the UE-48LI2500I into the brackets. Use 4 screws to fix the module on the front bracket.
2. Install another pair of bracket on the first one, fixed by buckles between them.
3. Insert the second one UE-48LI2500I in to the brackets.

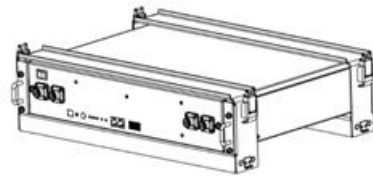

Figure3-4

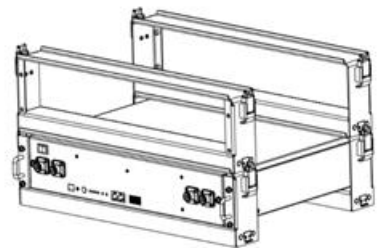

Figure3-5

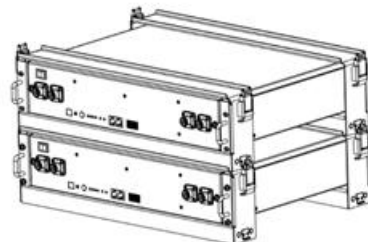

Figure3-6

- Stack the required number of battery and bracket combinations as described above, and fasten the top and bottom buckles. Shown as Figure3-7.

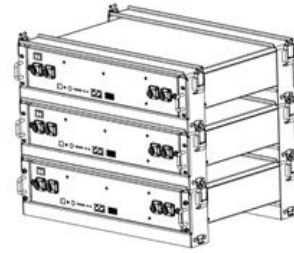

Figure3-7

3.2.3 Electrical installation

Before connecting the power cables, use multimeter to measure cable continuity, short circuit, confirm positive and negative, and accurately mark the cable labels.

Measuring methods:

- Power cable check: select the buzzer mode of multimeter and detect the both ends of the same color cable. If the buzzer calls, it means the cable is in good condition.
- Short circuit judgment: choose multimeter resistor file, probe the same end of positive and negative pole, if the resistor shows infinity, means that the cable is available.
- After visual testing of power line is connection, the positive and negative poles of the battery shall be connected respectively to the positive and negative poles of the opposite terminal.

It is better to add a circuit breaker between the inverter and the battery system. The selection of the circuit breaker requires:

$$\text{Voltage: } U > 60\text{V}$$
$$\text{Current: } I = \frac{\text{Inverter power}}{45\text{V}}$$

The circuit breaker is installed between the battery module and the inverter, as shown in Figure3-8:

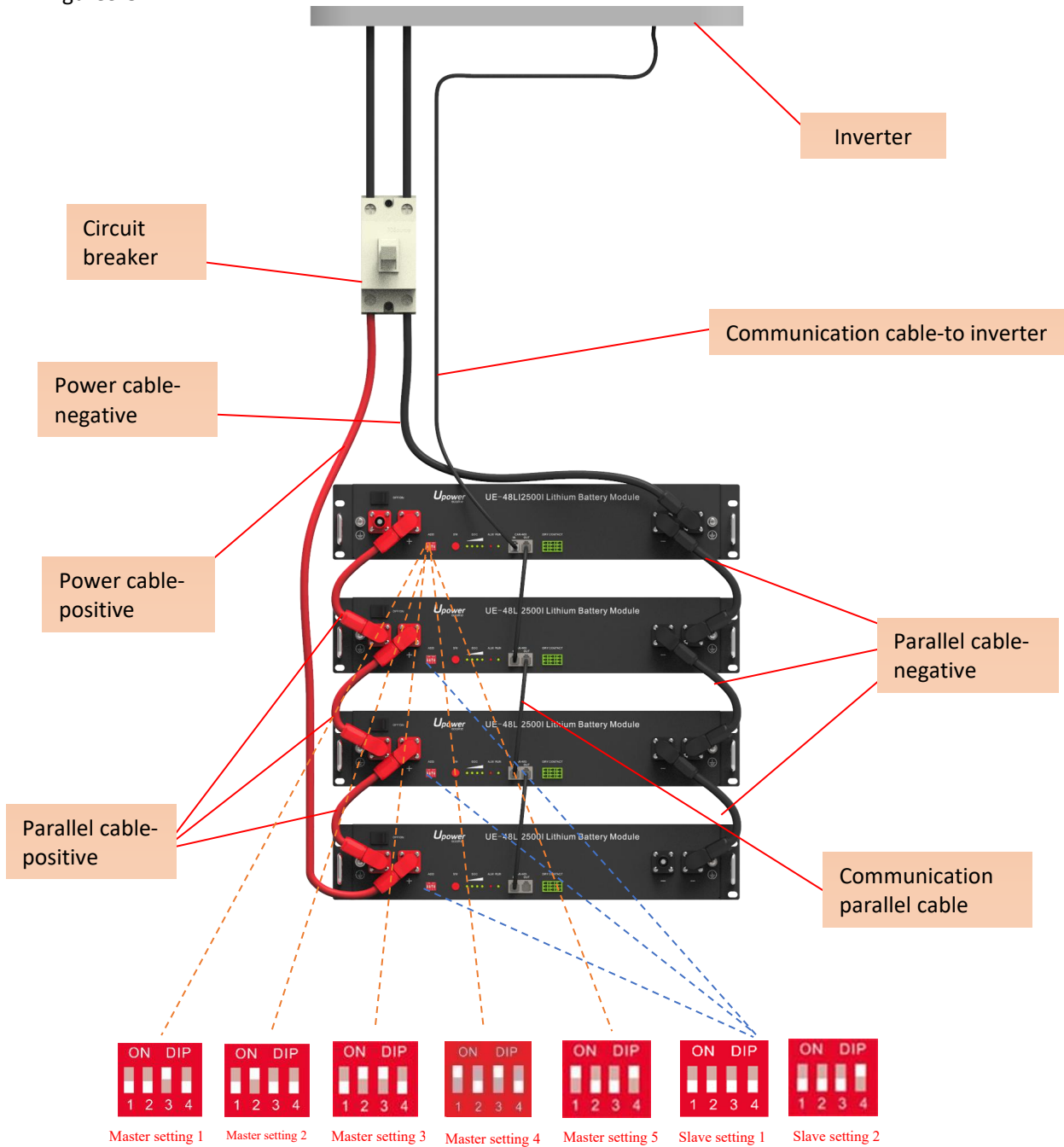

Figure3-8

Note: 1.After the whole system connection,set the master DIP mode according to the inverter model firstly,then start the battery.

2.The BAT-INV comms cable is from inverter comm port to master CAN IN port,BAT-BAT cable is from master CAN OUT to slave1 CAN IN,slave1 CAN OUT to slave2 CAN IN...

3.Each pair of power cable,it's limited continuous current is 120A,so if the inverter Max.work current more than 120A,please add power cable according to the proportion.

Note: For more information of matching inverter brands, please subject to the latest document <The list of compatibility between ESS and Inverters >.

3.2.4 Battery parameter settings on the inverter

Max Charging(Bulk) Voltage: 53.5V

Absorption Voltage: 53V

Float Voltage: 52.5V

Shut Down(cut off) Voltage: 47V

Shut Down(cut off) SOC: 20%

Restart Voltage: 49V

Max Charge Current: 25A*battery QTY

Max Discharge Current: 25A*battery QTY

Capacity: 1*UE-48LI2500I=50Ah

4 Use, maintenance and troubleshooting

4.1 Battery system usage and operation instructions

- 1 After completing the electrical installation, follow these steps to start the battery system.
- 2 Refer to the description of the DIP switch of 2.3.1 to prepare the battery module before starting up, then press the ON/OFF button to the ON position, next press and hold the SW button for 3 seconds.
- 3 After the indicator self-test, the RUN indicator will light and the SOC indicator will be on (100% SOC status in the Figure 4-1).

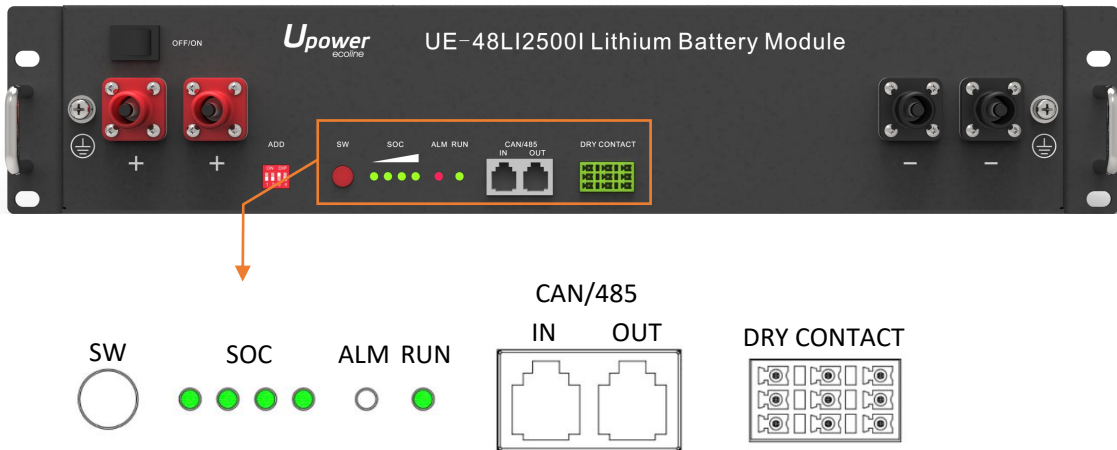

Figure 4-1



Caution:

After pressing the power button, if the battery status indicator on the front panel continues to be red, please refer to the "4.2 Alarm description and processing ". If the failure cannot be eliminated, please contact the dealer timely.

- 4 Use a voltmeter to measure whether the voltage of the circuit breaker battery access terminal is higher than 42V, and check whether the voltage polarity is consistent with the inverter input polarity. If the circuit breaker battery input terminal has a voltage output and is greater than 42V, then the battery begin to work normally.
- 5 After confirming that the battery output voltage and polarity are correct, turn on the inverter, close the circuit breaker.
- 6 Check if the indicator of the inverter and battery connection (communication indicator and battery access status indicator) is normal. If it is normal, successfully complete the connection between the battery and the inverter. If the indicator light is abnormal, please refer to the inverter manual for the cause or contact the dealer.
- 7 Battery modules can be connected in parallel up to 40 units.

Table 4-1 Battery& Inverter power matching table

Hybrid Inverter	Off-grid Inverter	UE-48LI2500I	
EPS(backup port) AC Output power	AC Output Power	Min. parallel number	System Energy (kWh)
≤ 1.2kW		1	2.4
≤ 2.4 kW		2	4.8
≤ 3.6 kW		3	7.2
≤ 4.8 kW		4	9.6
≤ 6.0 kW		5	12.0
≤ 7.2 kW		6	14.4
≤ 8.4 kW		7	16.8
≤ 9.6 kW		8	19.2
≤ 14.4 kW		12	28.8

Equipment Use	Charging	a) The battery's long-term continuous charging current should be ≤0.5C b) If the battery capacity is empty, please charge it within 18 hours after the battery is empty.
	Discharging	c) The long-term continuous discharge current of the battery should be ≤0.5C d) The recommend maximum depth of discharge (DOD)of Battery PACK is no more than 80%.

4.2 Alarm description and processing

When protection mode is activated or system failure occurred, the alarm signal will be given through the working status indicator on the front panel of the UE-48LI2500I. The network management can query the specific alarm categories.

If the fault such as single cell overvoltage, charging over-current, under-voltage protection, high-temp protection and other abnormalities which affects the output, please deal with it according to Table 4-2.

Table 4-2 Main alarm and Protection

Statue	Alarm category	Alarm indication	Processing
Charge state	Over-current	RED, Buzzer start	Stop charging and find out the cause of the trouble
	High temp	RED	Stop charging
Discharge state	Over-current	RED Buzzer start	Stop discharging and find out the cause of the trouble
	High temp	RED	Stop discharging and find out the cause of the trouble
	Total voltage undervoltage	RED Buzzer start	Start charging

Statue	Alarm category	Alarm indication	Processing
	Cell voltage undervoltage	RED Buzzer start	Start charging

4.3 Analysis and treatment of common faults

Analysis and treatment of common faults in the Table 4-3:

Table 4-3 Analysis and treatment of common faults

No.	Fault phenomenon	Reason analysis	Solution
1	The indicator does not respond after the power on	Total voltage lower than 35V	Check the total voltage
2	No DC output	Battery data status is abnormal. Battery gets into over-discharged protection	Read the battery information on the monitor.
3	The DC power supply time is too short	Battery capacity become smaller	Storage battery replacement or add more modules
4	The battery can't be fully charged to 100%	Charging voltage is too low	Adjust charging voltage at 53.5V or 54V
5	The power cable sparks once power on and ALM light RED	Power connection short-circuit	Turn off the battery, check the cause of the short circuit
6	Communication fault	The DIP setting of the master is wrong/ the battery type of the inverter is wrong/ Communication cable used incorrectly/ communication cable is incorrectly connected at the battery comm port or the inverter comm port/ The battery firmware version is not support the inverter	Check these possible cause one by one

If you need any technical help or have any question, please contact the seller in time.

U*power*
ecoline